











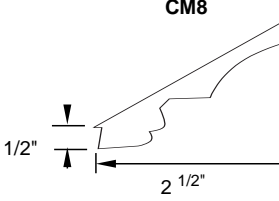
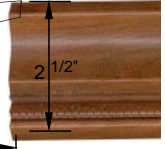
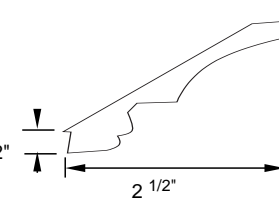

- *Index*
- *Moldings*
- *Legs, Posts, & Plate Covers*
- *Appliques, Corbels & Brackets*
- *Arched Valances & Mantels*
- *Fireplace Mantels, Toekick, & Feet*

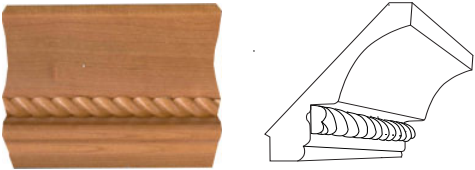
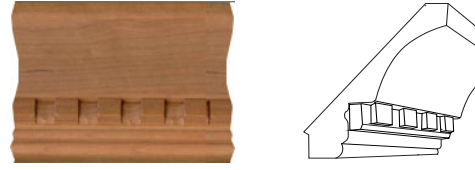
## Moldings & Decorative Accessories

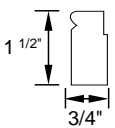
Page Location	Item Type	Nomenclature
138	Appliques (Grape/Shell/Acanthus)	APP
139	Arched Radius Decorative Valance	ARDV
139	Arched Valance	AV
139	Arched Valance "Shaker"	AVS
135	Beaded Top/Bottom Molding	BTBM8
135	Beaded Top/Bottom Molding "Pearled"	BTBM8-PEARL
136	Bottom Casement Molding	BCM8
140	Bunn Foot	BUNN
138	Corbel "Grape", "Shaker", " or "Scroll"	CBL-G / CS / CR
140	Corner Foot	CFT
136	Counter Top Molding	CTM8
136	Counter Top Molding "Egg and Dart"	CTM8-E&D
135	Crown Molding	CM8
136	Crown Molding "Coved"	CMC10
136	Crown Molding "Egg and Dart"	CML10
135	Crown Molding "Pearled"	CM8-PEARL
136	Crown Molding "Small"	CMS8
136	Crown Molding "Tall"	CMT
136	Crown Molding Large Rope	CMLR10
135	Dentil Molding	DM8
137	Farm Legs	PFL
140	Fireplace Mantel	MANTEL-FP
140	Foot "Tulip"	FTT
135	Furniture Toekick	FTK8
136	Inside Corner Molding	ICM8
138	L Bracket "Shaker" or "Transitional"	LBS / LBT
135	Light Valance Molding	LVM8
135	Light Valance Shaker Molding	LVSH8
139	Mantel	MANTEL
139	Mantel "Shaker"	MS
136	Mirror Trim	MT8
136	Outside Corner Molding	OCM8
137	Pilaster Legs	PIL
137	Pilaster Shaker Legs	PLS
137	Pilaster Transitional Legs	PLT
137	Plates - Outlet Covers	PLATE
137	Reeded Post	RP6X6
135	Rope Molding	RM8
138	Roundell (3" or 6")	ROUNDELL
135	Scribe	SS8
136	Shoe Molding	SHOE8
140	Single Foot	SFT
135	Toekick Cover	TKC8
140	Toekick Cover - Arched	TKCA
140	Toekick Cover - Ornamental	TKCO
135	Toekick End	TKE
136	Top Casement Molding	TCM8
135	Valance	V4M

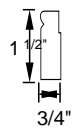
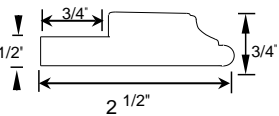
# Moldings & Decorative Accessories : Moldings

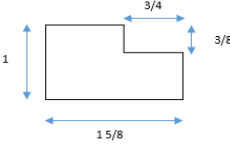
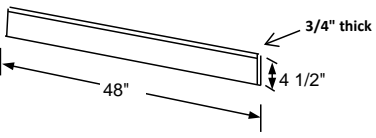
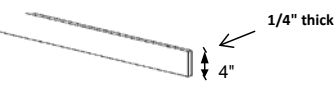
## Moldings

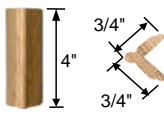
<p><b>Crown Molding</b></p>  <p>CM8</p>  <p>Sold in 8 Foot Lengths</p>	<p><b>Crown Molding - Pearl</b></p>  <p>CM8-PEARL</p>  <p>Sold in 8 Foot Lengths</p>
<p><b>Rope Molding</b></p>  <p>RM8</p>  <p>Not available in Oak</p> <p>Sold in 8 Foot Lengths</p>	<p><b>Dentil Molding</b></p>  <p>DM8</p>  <p>Not available in Oak</p> <p>Sold in 8 Foot Lengths</p>
<p><b>Crown Molding with Rope Molding</b>                      <b>Crown Molding with Dentil Molding</b></p>	
	
<p><b>Beaded Top Bottom Molding</b></p>  <p>BTBM8</p>  <p>Sold in 8 Foot Lengths</p>	<p><b>Pearl Beaded Top / Bottom Molding</b></p>  <p>BTBM8-PEARL</p>  <p>Not available in Oak</p> <p>"Embossed" Pearl Detail</p> <p>Sold in 8 Foot Lengths</p>
<p><b>Light Valance Molding</b></p>  <p>LVM8</p> <p>Sold in 8 Foot Lengths</p>	<p><b>Scribe Molding</b></p>  <p>SS8</p>  <p>Sold in 8 Foot Lengths</p> <p>Can also be used as batten molding</p>
<p><b>Light Valance Shaker Molding</b></p>  <p>LVSH8</p> <p>Sold in 8 Foot Lengths</p>	<p><b>Valance</b></p>  <p>V4M</p>
<p><b>Toe Kick Covers</b></p>  <p>TKC8</p> <p>Sold in 8 Foot Lengths</p>	<p><b>Furniture Toe Kick</b></p>  <p>FTK8</p> <p>Sold in 8 Foot Lengths</p>
<p><b>Toe Kick End</b></p>  <p>TKE</p>	

# Moldings & Decorative Accessories : Moldings

## Moldings

### Crown Molding Large-Egg & Dart



"Embossed" Egg and Dart Detail  
 Not available in Oak  
 Sold in 10 Foot Lengths

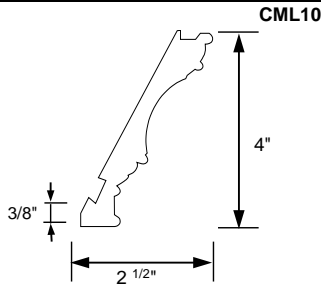

### Crown Molding Large - Rope



CMT10 NO ROPE OR EGG AND DART  
 "Embossed" Rope Detail  
 Not available in Oak  
 Sold in 10 Foot Lengths

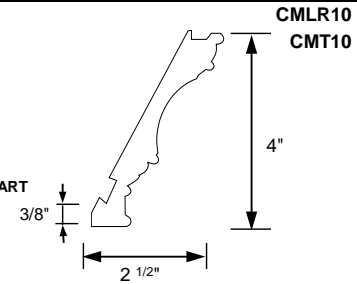

### Crown Molding Covered

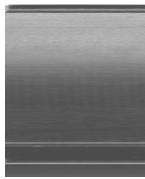

Not available in Oak  
 Sold in 10 Foot Lengths

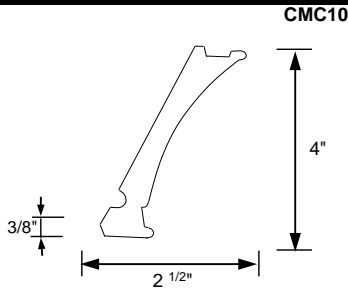

### Crown Molding "Small"



Sold in 8 Foot Lengths

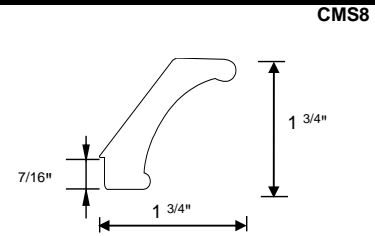

Available with GHS series in the following finishes ONLY:

Natural Maple	Chestnut Maple	Espresso Maple	Bronze Oak	Eggshell
Autumn Maple	Auburn Maple	Natural Oak	White	Gray

### Counter Top Molding



Sold in 8 Foot Lengths  
 Not available in any Painted Finishes

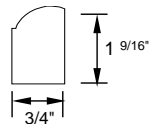

### Counter Top Molding - Egg & Dart



"Embossed" Egg & Dart Detail

Sold in 8 Foot Lengths  
 Not available in Oak or in any Painted Finishes

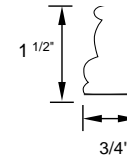

### Top Casement Molding



Sold in 8 Foot Lengths  
 Not available in Oak

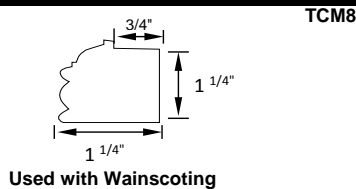

Used with Wainscoting

### Bottom Casement Molding



Sold in 8 Foot Lengths  
 Not available in Oak

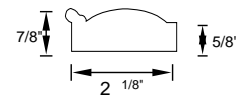

Used with Wainscoting

### Inside Corner Molding

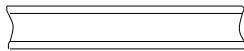

Sold in 8 Foot Lengths

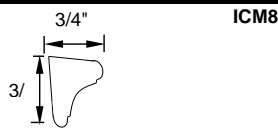

### Outside Corner Molding



Sold in 8 Foot Lengths



### Mirror Trim Molding

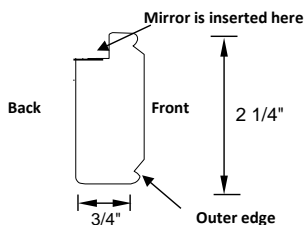

\*Available in all Cherry, Maple, and Painted finishes.

NOT AVAILABLE in OAK

### Shoe Molding

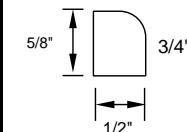

Sold in 8 Foot Lengths

Available with GHS series in the following finishes ONLY:

Natural Maple	Chestnut Maple	Espresso Maple	Bronze Oak	Eggshell
Autumn Maple	Auburn Maple	Natural Oak	White	Gray

# Moldings & Decorative Accessories : Legs, Posts & Plate Covers

## Decorative Accessories- Legs/Posts

List  
Price

List  
Price

### Pilaster Farm Leg

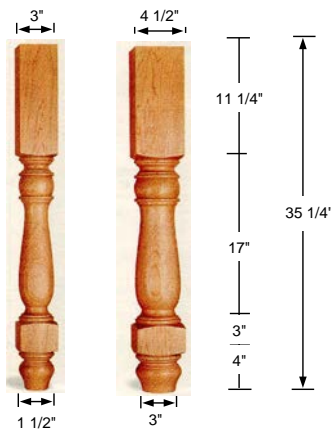

PFL030335  
PFL040435

Not available in Oak

### Reeded Post

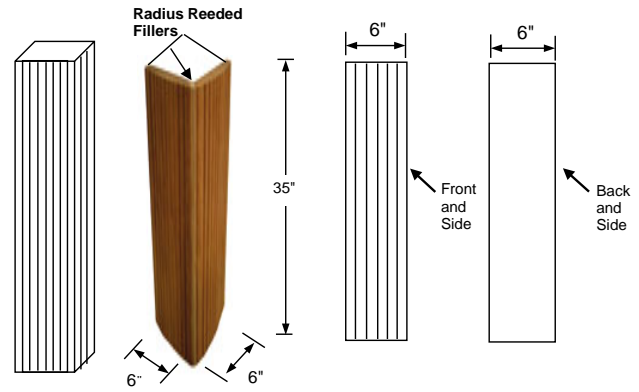

RP6X6

### Pilaster Leg "Shaker"

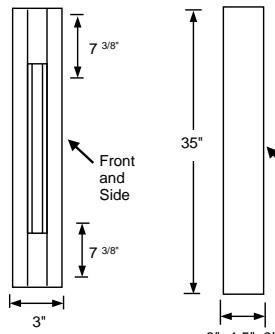

(3") PLS030335  
(6") PLS060635  
(4.5") PLS04504535

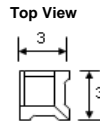

All Sides Finished

Not available in Oak

### Pilaster Leg "Transitional"

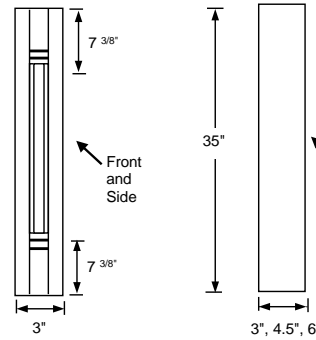

(3") PLT030335  
(6") PLT060635  
(4.5") PLT04504535

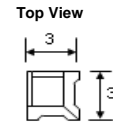

All Sides Finished

Not available in Oak

### Pilasters

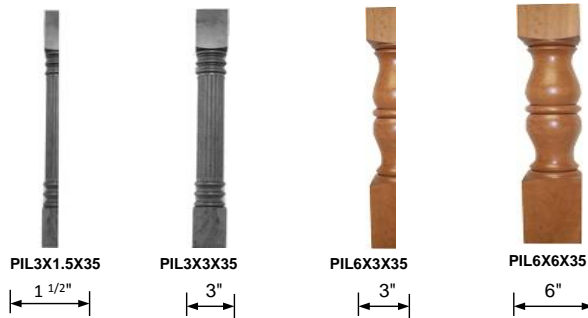

PIL3X1.5X35  
PIL3X3X35  
PIL6X3X35  
PIL6X6X35

Not available in Oak

## Decorative Accessories- Miscellaneous

### Plate Covers

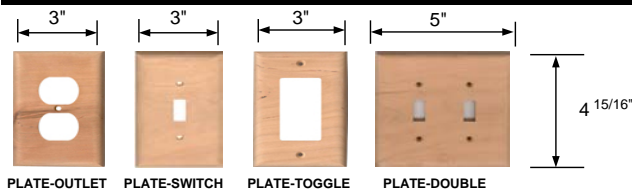



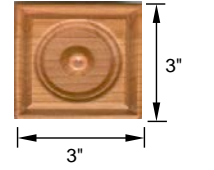
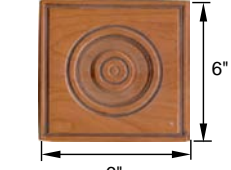
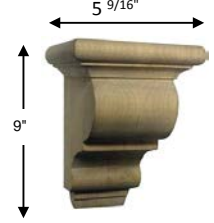
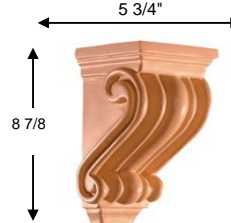
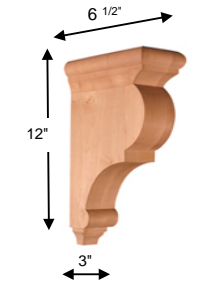



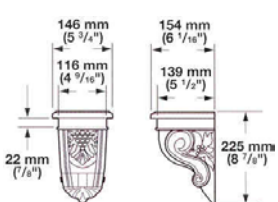

PLATE-OUTLET  
PLATE-SWITCH  
PLATE-TOGGLE  
PLATE-DOUBLE

# Moldings & Decorative Accessories : Appliques, Corbels & Brackets

## Decorative Accessories- Appliques, Corbels, and Brackets

<p><b>Applique- Grape</b></p> <p>APP-G20X4.5</p>  <p>Not available in Oak Recommended for kitchen application</p>	<p><b>Applique- Shell</b></p> <p>APP-S20X4.5</p>  <p>Not available in Oak Recommended for library application</p>
<p><b>Applique- Small Acanthus Cap</b></p> <p>APP-A5X3</p>  <p><u>Not Available in Oak</u></p>	<p><b>Applique- Large Acanthus Cap</b></p> <p>APP-A4.5X5</p>  <p><u>Not Available in Oak</u></p>
<p><b>Roundell</b></p> <p>ROUNDELL3X3</p>  <p><u>Not Available in Oak</u></p>	<p><b>Roundell</b></p> <p>ROUNDELL6X6</p>  <p><u>Not Available in Oak</u></p>
<p><b>Corbel-Shaker</b></p> <p>CS0509</p>  <p><u>Not Available in Oak</u></p> <p>Dimensions: 5 9/16" Wide by 9" High by 6" Deep</p>	<p><b>Corbel-Scroll</b></p> <p>CR0509</p>  <p><u>Not Available in Oak</u></p> <p>Dimensions: 5 3/4" Wide by 8 7/8" High by 5 3/4" Deep</p>
<p><b>"L" Bracket - "Shaker"</b></p> <p>LBS12</p>  <p><u>Available In Oak</u></p> <p>Dimensions: 3" Wide by 12" High by 6 1/2" Deep</p>	<p><b>"L" Bracket - "Transitional"</b></p> <p>LBT14</p>  <p><u>Not Available in Oak</u></p> <p>Dimensions: 3" Wide by 14" High by 6" Deep</p>
<p><b>Corbel-Grape</b></p> <p>CBL-G5X9</p>    <p><u>Not Available in Oak</u></p>	

## Decorative Accessories - Arched Valances and Mantels

### Arched Valance

**\*\*NOT AVAILABLE IN OAK\*\***

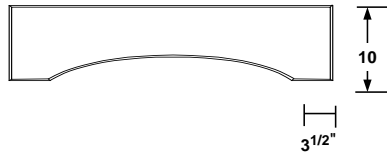

**\*\*\*Valance Cannot Be Trimmed**

Center Height	
AV3010	7"
AV3610 - AV7210	5"

- AV3010
- AV3610
- AV4210
- AV4810
- AV5410
- AV6010
- AV6610
- AV7210

### Arched Valance- "Shaker" 8" TALL

**\*\*NOT AVAILABLE IN OAK\*\***

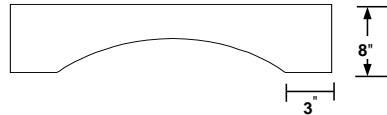

**\*\*\*Valance is Trimmable**

Center Height	
AVS4808 - AVS6608	7"

- AVS4808
- AVS5408
- AVS6008
- AVS6608

*\* Note: This valance to be used with PCCS034818 L/R and PCCS034824 L/R*

### Arched Valance- "Shaker"

**\*\*NOT AVAILABLE IN OAK\*\***

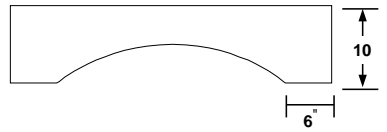

**\*\*\*Valance is Trimmable**

Center Height	
AVS3010	7"
AVS3610 - AVS7210	5"

- AVS3010
- AVS3610
- AVS4210
- AVS4810
- AVS5410
- AVS6010
- AVS6610
- AVS7210

### Arched Radius Decorative Valance

**\*\*NOT AVAILABLE IN OAK\*\***

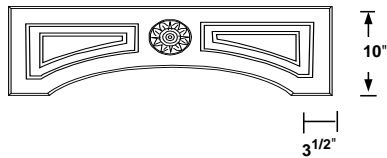

**\*\*\*Valance Cannot Be Trimmed**

Center Height	
ARDV3010	7"
ARDV3610	7"
ARDV4210 - ARDV7210	7 7/16"

- ARDV3010
- ARDV3610
- ARDV4210
- ARDV4810
- ARDV5410
- ARDV6010
- ARDV6610
- ARDV7210

*\*Note: This valance cannot be used with a Mantel*

### Mantels

**\*\*NOT AVAILABLE IN OAK\*\***

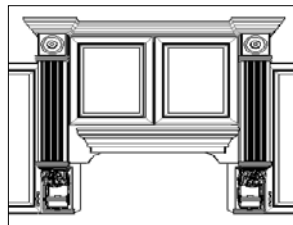

*Mantels should only be used with an Arched Valance "AV"*

- MANTEL27
- MANTEL30
- MANTEL33
- MANTEL39
- MANTEL45
- MANTEL51
- MANTEL57
- MANTEL60
- MANTEL69

### Mantels- "Shaker"

**\*\*NOT AVAILABLE IN OAK\*\***



*Shaker Mantels should be used with an Arch Valance Shaker "AVS".  
Can be used with either 8" or 10" AVS*

- MS29
- MS35
- MS41
- MS47
- MS53
- MS59
- MS65
- MS71

# Moldings & Decorative Accessories : Fireplace Mantels, Toekick & Feet

## Decorative Accessories - Fireplace Mantels, Toekick, and Feet

### Fireplace Mantels \*\*NOT AVAILABLE IN OAK\*\*



- MANTEL36-FP
- MANTEL42-FP
- MANTEL48-FP
- MANTEL60-FP

### Toe Kick Covers - Ornamental \*\*NOT AVAILABLE IN OAK\*\*

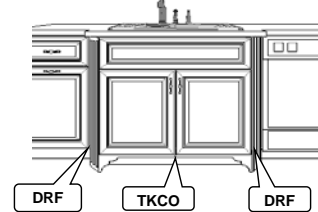

TKCO shown with Diagonal Reed Filler

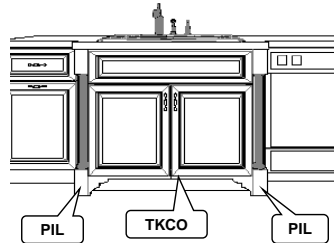

TKCO shown with Pilasters

In order to achieve this effect, you need to order a DRF3/96 and cut it down to two 34 1/2" high DRFs.

- TKCO12
- TKCO15
- TKCO18
- TKCO21
- TKCO24
- TKCO27
- TKCO30
- TKCO33
- TKCO36
- TKCO42
- TKCO48
- TKCO54
- TKCO60
- TKCO66
- TKCO72

### Toe Kick Covers - Arched \*\*NOT AVAILABLE IN OAK\*\*

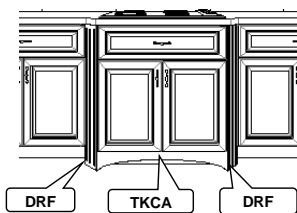

TKCA shown with Diagonal Reed Filler

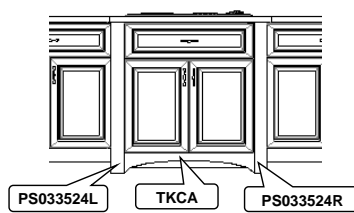

TKCA shown with Shaker Pilasters

In order to achieve this effect, you need to order a DRF3/96 and cut it down to two 34 1/2" high DRFs.

- TKCA12
- TKCA15
- TKCA18
- TKCA21
- TKCA24
- TKCA27
- TKCA30
- TKCA33
- TKCA36
- TKCA42
- TKCA48
- TKCA54
- TKCA60
- TKCA66
- TKCA72

### Tulip Foot FTT0304 79 Bun Foot

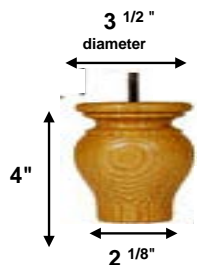

Not available in Oak  
Installation conflicts with toe kick!

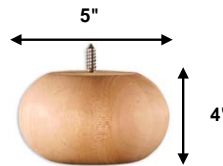

Not available in Oak  
Installation conflicts with toe kick!

### Single Foot Left or Right Hand SFTL/R 29 Corner Foot

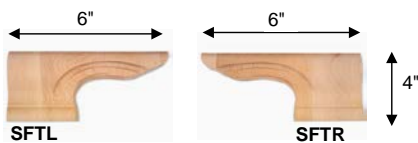

Not available in Oak



Not available in Oak

There is a block over the side that sits below the cabinet door, so you must order either a Left Hand or a Right Hand Corner Foot